

Prestigio PSP3537 DUO



Unboxing



Getting started



Basics



Phone



Messages



Mail



Camera



MultiMedia



Web & network



Bluetooth



Playstore



Maps & navigation



Utilities



Specifications



Troubleshooting

You may find detailed warranty information at: www.prestigio.com/support/warranty-terms.

© Copyright 2017 Prestigio. All rights reserved.

Prestigio Unboxing



Inside your package
Your phone at a glance
Buttons

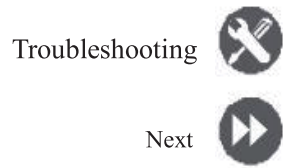

Inside your package

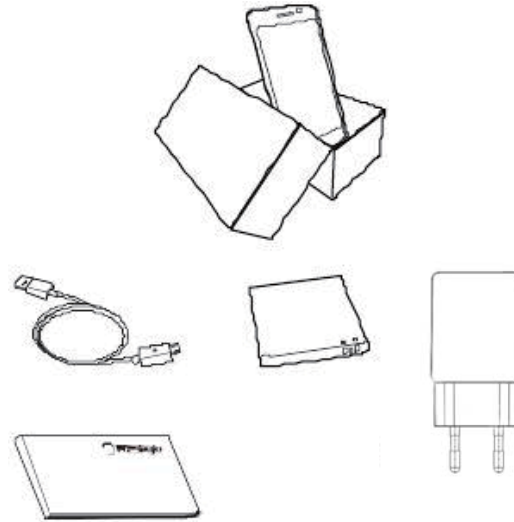

- Prestigio MultiPhone
- USB cable
- Battery
- Adapter
- Travel adapter (for UK only)
- Quick start guide
- Legal & safety notices
- Warranty card

Your phone at a glance

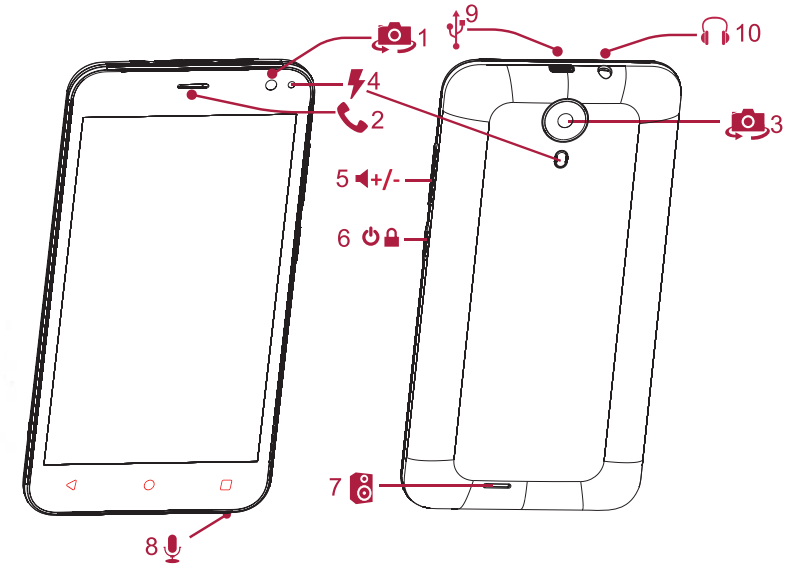

1. Front camera
2. Earpiece
3. Rear camera
4. Flash
5. Volume button
6. Power button
7. Speaker
8. Microphone
9. MicroUSB port
10. Earphone jack

Prestigio



Inside your package
Your phone at a glance
Buttons



Menu



Back

Troubleshooting







Next



Buttons

The back, start and search keys help you navigate your phone.

- Tap  to open a list of options available on the current screen. To open the list of recent apps, tap and hold .
- Tap  to return to the home screen.
- Tap  to return to the previous screen.



Do not cover the antenna area with your hands or other objects. This may cause connectivity problems or drain the battery.



Please read the "Legal and safety notices" in your package before use.

Prestigio Getting started



Installation

Power on your phone

Home screens

List menu



Menu



Back

Troubleshooting



Next



Congratulations on your purchase and welcome to Prestigio. To get the most from your product and enjoy all that Prestigio has to offer, please visit: www.prestigio.com/catalogue/MultiPhones

For more details about your product, please visit: www.prestigio.com/support

Installation

Follow the steps below to prepare your phone for using. Remember to turn off your mobile phone before removing the rear panel.

- 1 Remove the rear panel.

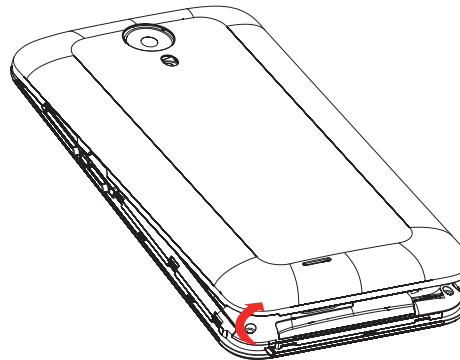

- 2 Take out the battery.

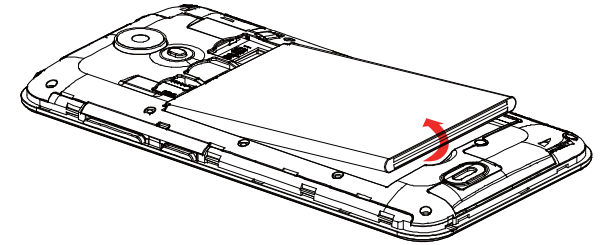

- 3 Insert the SIM card.
Insert the SIM card.

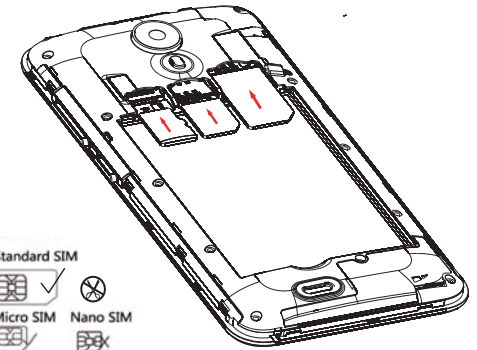

www.prestigio.com

Prestigio



Installation
Power on your phone
Home screens
List menu



Menu



Back

Troubleshooting



Next



4

Insert a memory card.
Insert a memory card.

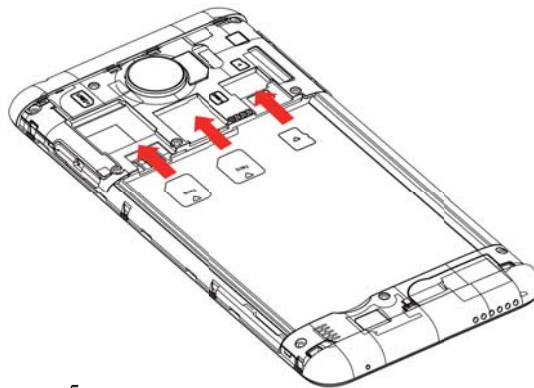

5

Insert the battery into the
battery compartment.

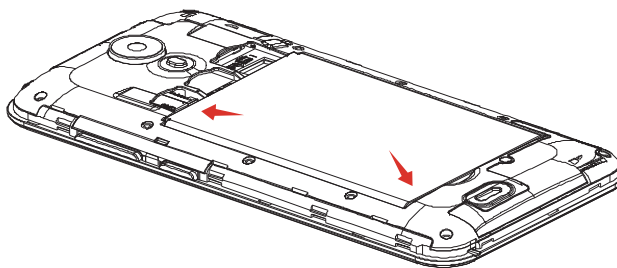

6

Put the rear panel back.

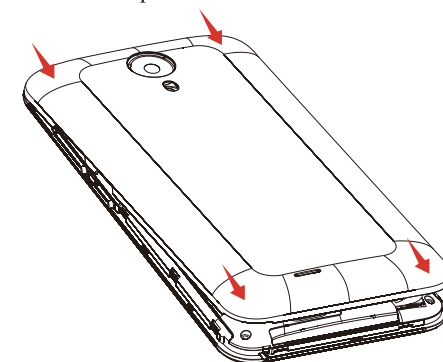

- The use of incompatible SIM cards, manually cut SIM cards, or SIM card adapters may damage the cards or the device, and it may corrupt the data stored on the cards.
- Scratching or bending of the SIM cards may result in the loss of contacts and information, so be careful when handling, inserting, or removing the cards.



Frequent writing and erasing of data shortens the lifespan of memory cards.

Prestigio



- Installation
- Power on your phone**
- Home screens
- List menu



Menu



Back

Troubleshooting



Next



Dual SIM standby



The device supports two SIM cards for voice calls and data connection. During a voice call or data transfer via one SIM card, the other SIM card becomes inactive (not registered with your mobile network operator). This means that you cannot receive incoming calls or use data connection via the inactive SIM card. When the call or data transfer ends, both SIM cards will become active and show on the list of registered networks.

Power on your phone

- 7 Press and hold the power button for a few seconds.

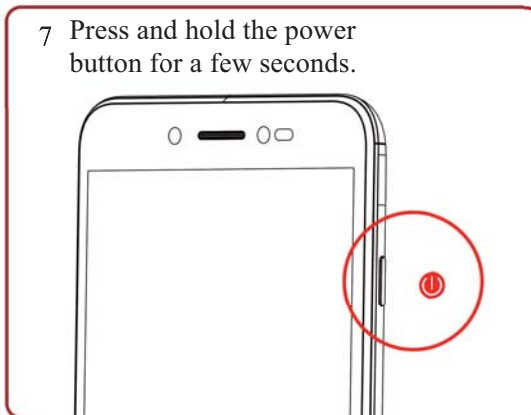

When turning on the device for the first time, follow the on-screen instructions to set up your device.



To turn off your phone, press and hold the power key, and then tap **Power off** on the pop-up screen.

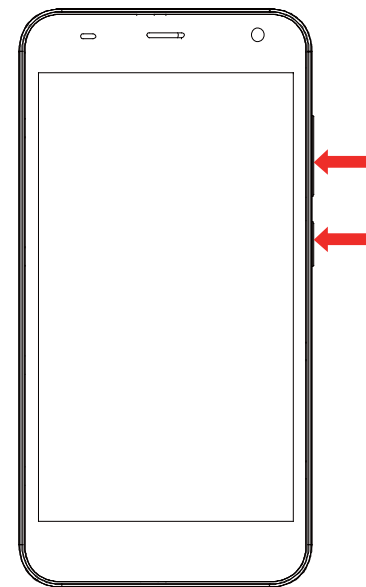

Prestigio



Installation
Power on your phone
Home screens
List menu

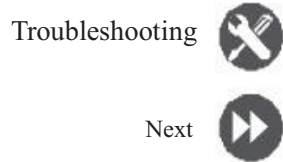

Home screens

Your home screen is the starting point to access all of your phone's features. The home screen can have multiple panels. To view other panels, swipe left or right.

Tap  to return to the home screen.

Your phone's home screen consists of the following:

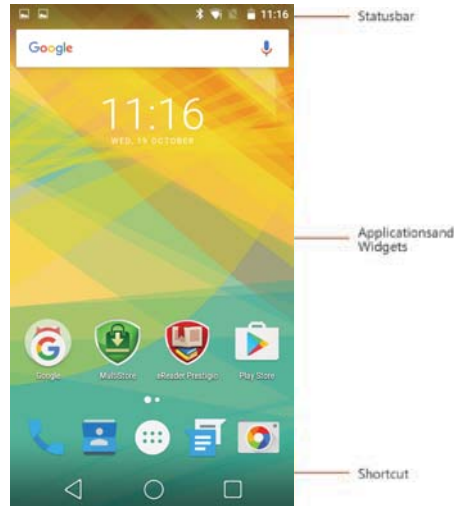

Personalise your wallpaper

Pick your favourite photo as your Home wallpaper. Choose from the available wallpapers, or use any photo you have taken with the camera.

1. On the homescreen, tap  > **Wallpaper**
2. Select an image and tap **Set wallpaper**.

Add an app icon to home screen

1. On the homescreen, tap  to open the list menu.
2. Tap and hold an application icon.
3. Drag it into a panel preview.

Remove an item on home screen

1. Tap and hold an item to remove.
2. Drag the item to the **Remove** option.
3. When the **Remove** option turns red, release the item.

Prestigio



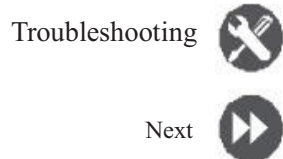

Installation
Power on your phone
Home screens
List menu



List menu

All your apps' icons can be found on the list menu.

On the home screen, tap to  open the list menu.

Tap  or  to return to the home screen. Your phone's list menu consists of the following:

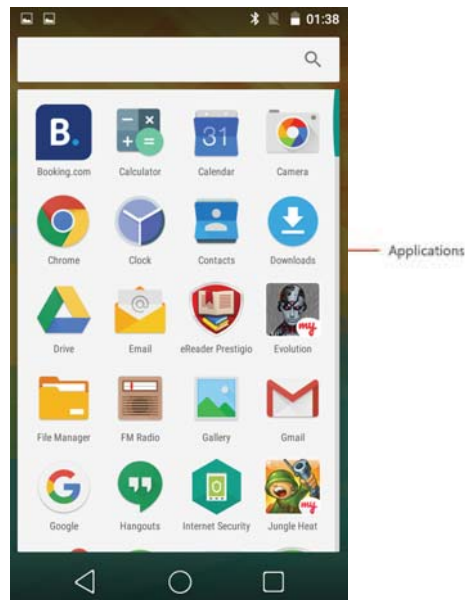

Prestigio Basics



- Finger tips**
- Charge the battery**
- Connect to your PC**
- Rotate the screen**
- Lock and unlock the screen**
- Use the notifications panel**
- Enter text**
- System update**
- Status icons**

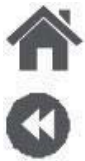

Menu



Troubleshooting



Next

Finger tips

Only use your fingers to use the touch screen.

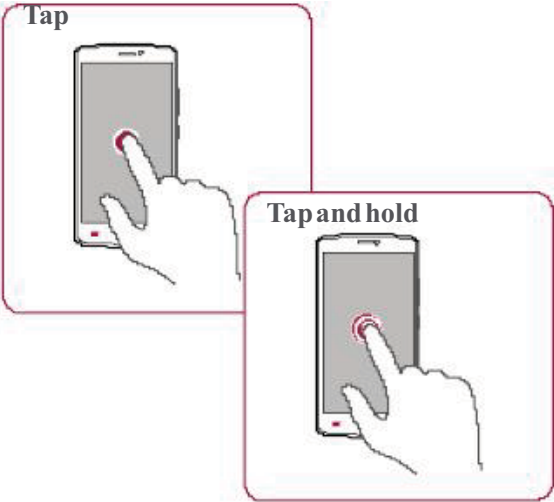

- To open an application, to select a menu item, to press a non-screen button, or to enter a character using the on-screen keyboard, tap it with a finger.
- Tap and hold an item for more than 2 seconds to access available options.

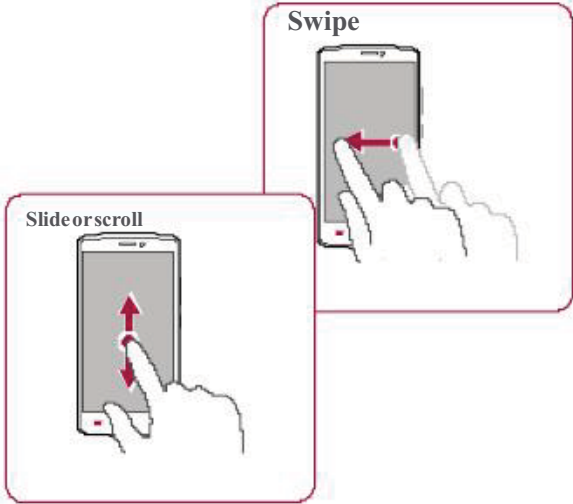

- Quickly swipe your finger vertically or horizontally across the screen to go to other home pages, scroll through documents, and more.
- Slide your finger vertically across the screen to open drop-down menu. Drag up or down to scroll.

Prestigio



Finger tips

Charge the battery

Connect to your PC

Rotate the screen

Lock and unlock the screen

Use the notifications panel

Enter text

System update

Status icons



Menu



Back

Troubleshooting



Next

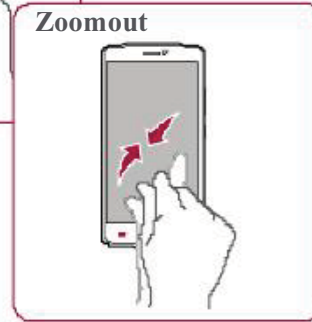
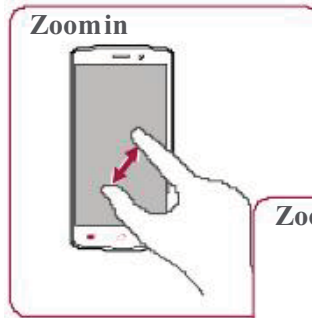

- Spread two fingers apart on a webpage, map, or image to zoom in a part.
- Pinch two fingers together on a web page, map, or image to zoom out a part.



- Flick left or right on the home screen or the applications screen to see another panel. Flick up or down to scroll through a webpage or a list, such as contacts.

Prestigio



Finger tips

Charge the battery

Connect to your PC

Rotate the screen

Lock and unlock the screen

Use the notifications panel

Enter text

System update

Status icons



Menu

Troubleshooting



Back

Next



Charge the battery

A new battery is partially charged. The battery icon at the upper-right corner shows the level of charging status.

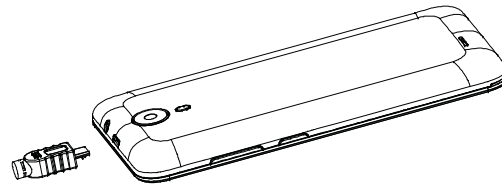

1. Plug the small end of the charger into the micro USB port of the device, and plug the large end of the charger into an electric socket.
2. After being fully charged, disconnect the device from the charger. First unplug the charger from the device, and then unplug it from the electric socket.



Always use authentic accessories to optimise your battery performance. Non-authentic accessories (eg. chargers) can damage your battery and even your phone.

Optimise your battery performance

Here are some tips to help you optimise your battery performance.

- Always ensure that your phone profile is appropriately set to meet your actual usage.
- If you are not using Bluetooth, Wi-Fi, GPS or other applications, turn them off.
- Adjust the intensity of your display screen's backlight to low or medium level and for the shortest duration.
- Avoid using or placing your phone near magnetic objects (eg. a radio or television) or on metal surfaces, which will impact the network connection and ultimately drain power from your battery.

Prestigio



Finger tips

Charge the battery

Connect to your PC

Rotate the screen

Lock and unlock the screen

Use the notifications panel

Enter text

System update

Status icons



Menu



Back

Troubleshooting



Next



Connect to your PC

You may need to connect your phone to a PC in order to complete activation. Your phone's micro USB port allows you to exchange media and other files with a PC.

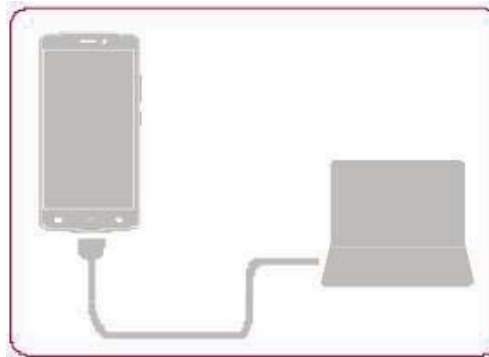

Load files from your PC

1. Connect your phone to the PC with the included USB cable.
2. Open the notifications panel, and then tap **Connected as a media device > Media device (MTP)**.
3. Transfer files between your phone and the PC.

Rotate the screen

For many screens, you can automatically change the screen orientation from portrait to landscape by turning your phone sideways. When entering text, you can turn your phone sideways to bring up a bigger keyboard.

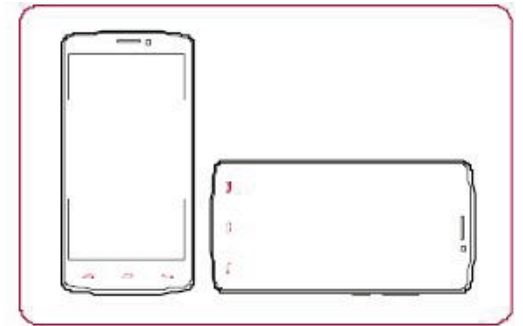

To prevent the display from rotating automatically, open the notifications panel and deselect **Auto rotation**.



- Some applications do not allow screen rotation.
- Some applications display a different screen depending on the orientation.

Prestigio



Finger tips

Charge the battery

Connect to your PC

Rotate the screen

Lock and unlock the screen

Use the notifications panel

Enter text

System update

Status icons



Menu



Back

Troubleshooting



Next



Lock and unlock the screen

When not in use, lock your phone to prevent unwanted operations and save the battery power.

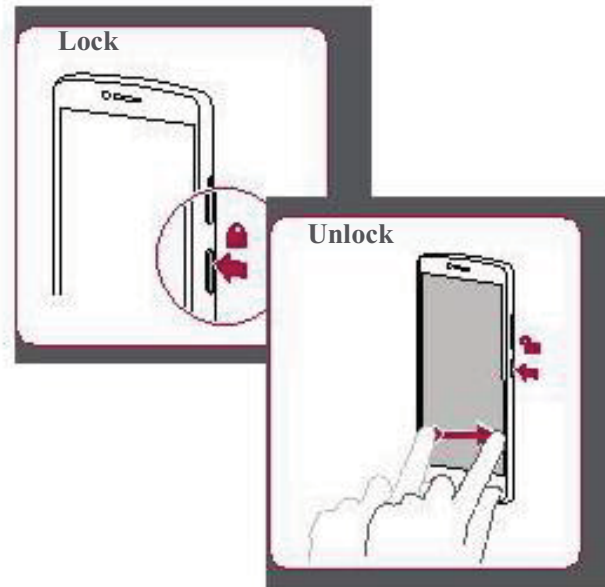

Autolock

You can set a time span for the screen to be locked automatically.

1. On the list menu, tap  **Settings>Display>Sleep.**

2. Select your desired time span.

Set screen lock pattern

Protect your personal information and prevent others from using your phone without your permission by setting a screen lock pattern, PIN, or password.

- On the list menu, tap  **Settings>Security>Screen lock.**



When your phone is locked, your phone can still:

- Receive calls, text messages, and other updates.
- Play music.
- Adjust the volume.

Prestigio



Finger tips

- Charge the battery
- Connect to your PC
- Rotate the screen
- Lock and unlock the screen
- Use the notifications panel
- Enter text
- System update
- Status icons

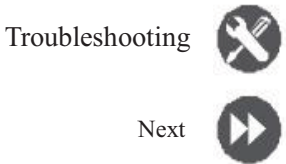
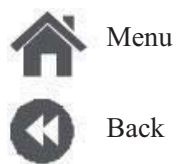

Use the notifications panel

Slide down from the top of the screen to open the notifications panel. When you get a new notification, you can open it to see what event or new info you have received. You can also quickly access settings from it. It allows you to easily turn airplane mode, Wi-Fi, and Bluetooth on and off. It also provides a shortcut to set the brightness and orientation of your screen.

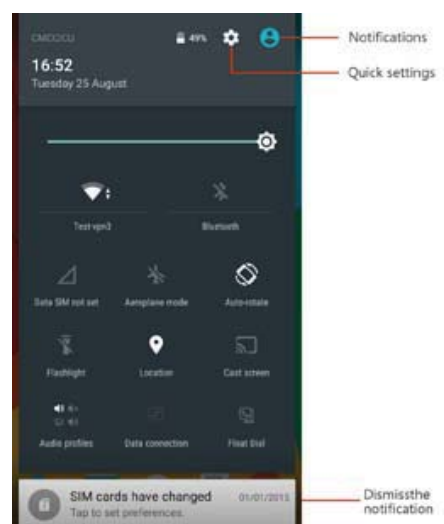

Enter text

Use the on-screen keyboard to enter text, such as contact information, mail, and web addresses.

Use the keyboard



1. Character keys
2. Shift key
3. Numbers and symbols key
4. Enter text by voice
5. Space key
6. Enter key
7. Backspace key

Prestigio



Finger tips

Charge the battery

Connect to your PC

Rotate the screen

Lock and unlock the screen

Use the notifications panel

Enter text

System update

Status icons



Menu

Troubleshooting



Back

Next



Enter text by voice

You also can enter the text by activating the voice input feature and then speak into the microphone. Your phone displays what you speak.

Voice typing: tap  on the screen.

Copy and paste text

- Tap a word, drag the circles before and after the word to highlight the section you want to copy, and tap .
- To paste the text, tap and hold at the point where you want to paste the text. Tap **Paste**.

System update

















Your phone can check and notify you if there is a new upgrade available. You can also manually check if there is an available update. You can set this option in  **Settings** > **About phone** > **updates**.



Do not press any keys while the device is upgrading.

Status icons

The icons in the status bar at the top of the screen give information about your phone:

 Silent mode activated	 3G network connected
 Vibration mode activated	 Wi-Fi connected
 Airplane mode activated	 Roaming (outside of
 Battery power level	 Bluetooth is activated
 Calls in progress	 Connected to PC
 microphone connected	 connected
 GPRS network connected	 No SIM card detected
 EDGE network connected	 Alarm is set
 HSPA network connected	

www.prestigio.com

normal service area)

Prestigio Phone



Calls

Contacts

Contact groups



Menu



Back

Troubleshooting



Next



Learn to use calling functions, such as making and answering calls, using options available during a call or customising and using call-related features.

Calls

Make and end a call

1. On the homescreen or list menu, tap

Phone.

2. Tap to open the dial pad.
3. Enter the phone number, and then tap .
4. Tap to end a call.

Answer a call

When you receive a phone call from a contact, the incoming call screen appears. To pick up the phone, slide to

Silence an incoming call

When a call comes in, press the power button or volume button to mute the ringing sound without rejecting the call

Set up a conference call

If network is available, you can make the first call or accept a call. Then simply dial each subsequent call to add it to the conference.

1. During a call, tap to make a call to another person.
2. The second number is dialled, and the first call is put on hold at this time.
3. Tap to add the contact to a conference call.



Makesure your SIM card is enabled with conference calling service. Contact your mobile operator for details.

Prestigio



Calls
Contacts
Contact groups



Menu



Back

Troubleshooting



Next



Make an emergency call

In some regions, you can make emergency calls even if you do not have a SIM card installed or your SIM card has been blocked.

1. On the homescreen, tap **Phone**.
2. Tap to open the dial pad.
3. Dial the emergency number for your location, and then tap .



If you are out of base station coverage, you will not be able to make an emergency call.



In Europe, the standard emergency number is 112; in the UK, it is 999.

Contacts

Contacts are stored in one of the two available phonebooks: SIM phone book (located on your SIM card) or the Smart phone book (located on your phone).

- To view your contacts, tap **People** on the homescreen or list menu.

Search for a contact

1. Scroll up or down the contact list.
2. Tap and enter the first few letters of the name in the search bar.
3. Select the contact from the option list.

Add a new contact

Method one:

1. On the homescreen or list menu, tap **Phone**.
2. Tap to open the dial pad.
3. Enter a number, tap , **Add to contacts**.
4. Add details as desired.
5. Tap **Done** to finish and save.

Method two:

1. Go to **People** to view the contact list.
2. Tap , to add a new contact.

Prestigio



Calls

Contacts

Contact groups



Menu



Back

Troubleshooting



Next



Import/Export contacts

1. Go to **People** to view the contact list.
2. Tap  > **Import/export**.
3. Select the contacts storage.
4. Follow the prompts to finish.



Delete contacts

1. Go to **People** to view the contact list.
2. Tap  > **Delete contact**.
3. Choose the contacts you wish to remove.
4. Tap **OK** to delete the contacts.

Contact groups

You can group your contacts as different groups. For different groups, you can use different identifications, and send messages to a group.

Add contacts to a group

1. Go to **People** to view the contact list.
2. Tap  to view contact groups.
3. Tap  to add contacts to a group.
4. Enter your group's name, and tap  to add contacts.

Prestigio Messages



Send a message

Check your message

Reply to a message

Forward or delete a message

Delete a conversation



Menu



Back

Troubleshooting



Next



Messages let you exchange text messages with other SMS and MMS devices via your cellular connection. Your sent and received messages are neatly grouped into conversations, by contact name or phone number.

Send a message

On the homescreen or list menu, tap

Messaging. And then tap  to start composing a new message.



1. Enter a phone number
2. Add picture/video/audio/slideshow
3. More options
4. Add a recipient from your contacts list
5. Send the message



There is a limit on the number of characters for a single text message (displayed above the send button). If you exceed the limit, your text message will be delivered as one but will be billed as more than one message.

www.prestigio.com

Prestigio



Send a message

Check your message

Reply to a message

Forward or delete a message

Delete a conversation



Menu

Troubleshooting



Back

Next



Check your message

Depending on your notification settings, your phone plays a sound, vibrates, or displays the message briefly in the status bar when you receive a new message.

- On the home screen or list menu, tap **Messaging**. To check a message, tap a conversation.

Reply to a message

1. On the messages screen, tap the conversation containing the message.
2. In the text box, enter your message.
3. Tap ➤ to send the message.

Forward or delete a message

1. On the messages screen, tap the conversation containing the message.
2. Tap and hold a message.
3. In the pop-up window, select **Forward** or **Delete**.

Delete a conversation

1. On the home screen or list menu, tap **Messaging** to display the messages screen.
2. Tap and hold a contact or phone number.
3. Tap 🗑️ at the bottom of the screen.

Prestigio Mail



Set up an email account

Send a mail

View your mails

Reply to a mail

Delete mails

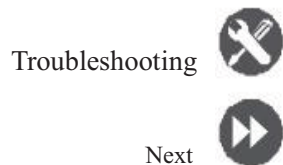
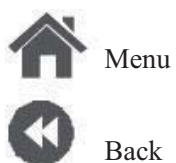

Use this application to send or view email messages. Learn to send or view email messages via your personal or company email account.

Set up an email account

1. On the home screen or list menu, tap **Email** and do one of the following:
 - If this is your first time adding an email account in Mail, move to the next step.
 - If you have already added an email account, then tap **☰** > **Settings** > **add account**.
2. Enter the email address and password for your email account.



When you finish setting up the email account, the email messages will download to your device.

Delete an email account

1. Go to **☰** **Settings** > **Accounts**.
2. Tap the email account you want to delete.
3. Tap **☰** > **Remove account**.

Send a mail

On the home screen or list menu, tap **Email**.

And then tap  to start composing a new mail.



1. Enter a recipient
2. Enter the mail subject
3. More options
4. Send the mail

Prestigio



Set up an email account

Send a mail

View your mails

Reply to a mail

Delete mails



Menu



Back



Troubleshooting



Next





View your mails

1. On the email inbox, tap  to check whether there is a new mail.
2. Tap the desired mail to read it.
 - Use  or  to view the previous or next mail.

Search for a mail

1. Tap  to display the search bar.
2. Choose a search option in the drop-down list.
3. Enter the first few letters of the mail sender or subject in the search bar.
4. Select the mail from the list.

Reply to a mail

1. On the email inbox, tap the email message.
2. Tap , and then compose your mail.
3. Tap  to send the mail.

Delete mails

-  Tap the mail you wish to delete, and then tap

Prestigio Camera



Your camera at a glance

Take a photo

Record a video

Photo and video settings



Menu



Back

Troubleshooting



Next



With your phone, you can take both photos and videos as desired. In addition to rear camera, there is a camera on the front for video calls and self-portraits.

- To use the camera, on the home screen or list menu, tap **Camera**.

Your camera at a glance

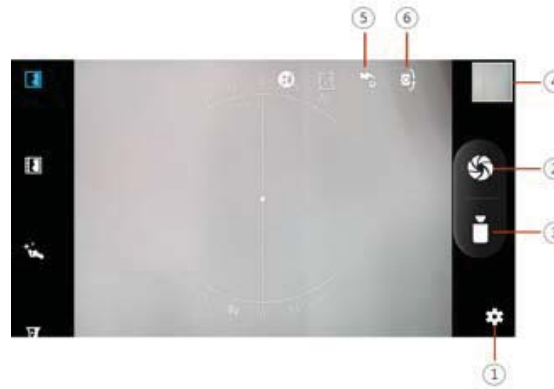

1. Phone/ video settings
2. Capture photo
3. Video recording
4. Image preview
5. Flash settings
6. Switch between front/rear camera

Take a photo

1. Turn on the camera.
2. Change the camera setting if necessary.
3. Point the camera at what you want to capture.
4. Tap to capture the photo.

Take a photo of yourself

1. Turn on the camera.
2. On the screen, tap
3. Tap to capture the photo.

Take a panoramic photo

You can capture anything wide or tall objects in a single photo with your phone.

1. Turn on the camera.
2. Scroll down the capture modes, and then tap
3. When you are ready to take the first shot, tap
4. A directional arrow appears. Pan your phone as smoothly as you can.
5. The camera will stitch the shots into a single photo.

Prestigio



Your camera at a glance

Take a photo

Record a video

Photo and video settings



Menu



Back

Troubleshooting



Next



Record a video



1. Turn on the camera.
2. When you are ready to start recording, tap .
3. To stop recording, tap .

Photo and video settings

Before you take a photo or record a video, customise your photo/video settings.

General settings	
GPS location info	Attach a GPS location tag to the photo.
Exposure	This determines how much light the camera's sensor receives.
Scene mode	Select your desired scene mode.
White balance	Select an appropriate white balance, so images have a true-to-life colour range.
Anti-flicker	Select a band to avoid the impacts on photos caused by flickers from lighting sources.
Restore defaults	Restore to default settings.
Photo settings	
Zero shutter delay	The ZSD (zero shutter delay) function helps you capture photos immediately.
Face detection	Set the ideal exposure and clarity of faces.
Self timer	Select a time span for shutter delay to take a self-portrait.

Picture size	Select from various standard sizes for your picture.
Preview size	Set the preview screen ratio before you take a photo.
ISO	An ISO value indicates the light sensitivity of your camera's imaging sensor. Higher values are for fast-moving or poorly-lit objects.
Video settings	
EIS	The EIS (Electronic Image Stabilization) function helps reduce blurring associated with the motion of a camera during exposure.
Time lapse interval	Set the time lapse interval to adjust the speed of your video output.
Video quality	Set the quality level for videos as this setting will affect your file size.

Prestigio MultiMedia



Gallery

Video player

Music player

FM radio



Menu



Back

Troubleshooting



Next



Your phone provides several multimedia for your entertainment. You can view your photo gallery, enjoy music, and watch videos.

Gallery

View your photos

1. On the home screen or list menu, tap

Gallery.

2. Browse an album or a group of photos.
3. Tap a photo to view it full-screen.

Zoom in and out

Spread two fingers apart on any place to zoom in. Pinch to zoom out, or double-tap to return.

Edit your photos

When viewing a photo, use the keys on the screen to edit the photos.

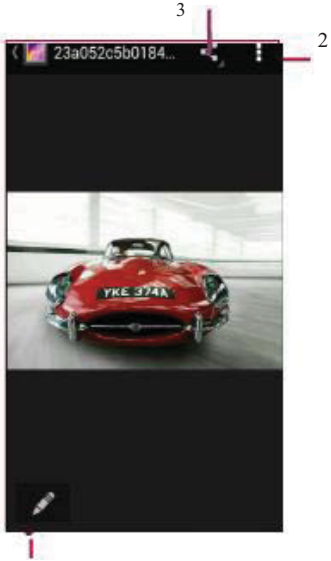

1. Edit the photo
2. More options
3. Share your photo

Prestigio



Gallery

Video player

Music player

FM radio



Menu



Back

Troubleshooting



Next



Video player

You can use the video player on your phone to watch videos.

Watch a video

1. On the home screen or list menu, tap **Videos**.
2. Select the video that you want to watch.
3. Tap the on-screen keys to control the video playback.
4. Press the volume button to adjust the sound.
5. Tap to select more options.

Music player

You can listen to your favourite music with the music player. The music app is a central hub for your favourite music whether it is stored in your phone or streamed through a music service.

Listen to music

1. On the home screen or list menu, tap **Music**.
2. Tap a song from the list, or tap  to find your desired song.
3. Tap the on-screen keys to control the music playback.
4. Press the volume button to adjust the sound.
5. Tap to select more options.

Prestigio



Video player
Music player
FM radio



Menu



Back

Troubleshooting



Next





FM radio

You can listen to radio programs with your phone.



You must connect a headset before using the FM radio on your phone.

Listen to a radio station

1. On the some screen or list menu, tap **FM Radio**.
2. Tap  > **Search**. It will start scanning automatically and save the available channels.
3. Use the on-screen keys to control playback:
4. Press the volume button to adjust the sound.
5. Tap  to select more options.

Prestigio Web & network



Connect to the Internet

Web browse



Menu



Back

Troubleshooting



Next



You can connect your phone to the Internet and browse a web page.

Connect to the Internet

Your phone connects to the Internet whenever necessary, using a Wi-Fi connection (if available) or your mobile operator's data connection.

Data connection

You can use your mobile operator's data connection.

Turn on data connection

1. Go to  **Settings** > **More...** > **Mobile networks** > **Data connection**.
2. Tap to turn on or off data connection.



Some apps and services may transfer data over your mobile operator's cellular network, which may result in additional fees. Contact your mobile operator for details.

Turn on data roaming

Connect to your mobile operator's partner networks and access data services when you are out

of your mobile operator's coverage area.

1. Go to  **Settings** > **Data usage**.
2. Tap  > **Data roaming** to turn it on or off.



Using data services while roaming may be costly. Check with your mobile operator for data roaming rates before you use data roaming.

Use your phone as a wireless router

Share your data connection with other devices by turning your phone into a wireless router.

1. Go to  **Settings** > **More...** > **Tethering & portable hotspot**.
2. Tap to turn on portable Wi-Fi hotspot.



The other device uses data from your data plan, which may result in data traffic costs. For info on availability and costs, contact your network service provider.

Prestigio



Connect to the Internet
Web browse



Menu



Back

Troubleshooting



Next



Wi-Fi

Connect the device to a Wi-Fi network to use the Internet or share media files with other devices.

Connect to a wireless network

1. Go to  **Settings** > **Wi-Fi**.
 2. Make sure **Wi-Fi** is switched to **On**.
 3. The Wi-Fi section will show the list of networks detected.
 4. Tap the desired Wi-Fi network you want to connect to.
- If you selected a secured network, you will be asked to enter the network key or password.

Web browse

You can use your phone to browse websites. Before browsing a website, please confirm that you have turned on data connection or Wi-Fi.

Browse a webpage

1. On the home screen or list menu, tap **Browser**.
2. Enter your search keywords or a web page address.



1. The previous web page
2. The next web page
3. Webpage preview
4. View **Bookmarks, History** and **Saved pages**.

Prestigio



Connect to the Internet
Web browse



Menu



Back

Troubleshooting



Next



Web page preview



1. View **Bookmarks**
2. Open a new page
3. Close the webpage

Prestigio Bluetooth



- Pair with a Bluetooth device
- Receive data via Bluetooth
- Send data via Bluetooth



Menu



Back

Troubleshooting



Next



Your phone can connect to a compatible Bluetooth device for exchanging data. Bluetooth creates a direct wireless connection between two devices over short distances.

Pair with a Bluetooth device

1. Go to **Settings** > **Bluetooth**.
2. Make sure **Bluetooth** is switched to **On**.
3. A list of available Bluetooth devices will appear.
4. Tap the device you wish to connect with.
5. The pairing is made if your pairing request is accepted by the other device.

Receive data via Bluetooth

1. Make sure **Bluetooth** is switched to **On**.
2. Tap your phone model to make it visible to all nearby Bluetooth devices.
3. Accept the request and pair with the other Bluetooth device(s).
4. Slide to open notifications panel, tap **Accept**.

Send data via Bluetooth

1. Select the file you want to share.
2. Tap to send the file via Bluetooth.
3. Select a device to start sending the file.



The files received via Bluetooth are stored in the Bluetooth folder.

Prestigio Play store



Search and install an app

Uninstall an app



Menu



Back

Troubleshooting



Next



Use the Google Play Store to purchase and download applications and games that are able to run on your phone. Choose from a wide variety of free and paid apps ranging from productivity apps, entertainment, to games.



- A Google Wallet™ payment service is required to purchase a paid app. You will be asked to confirm the method of payment when you purchase an app.
- The availability of Store and the selection of items available for download depend on your region.

Search and install an app

1. On the list menu, tap **Playstore**.
 2. Browse applications by category, or tap  to search with a keyword.
 3. Select an application to view information.
 4. To download it, tap **Install**.
- If there is a charge for the application, tap the price, and follow the prompts to complete the purchase.



Use a Wi-Fi connection to download large files.

Uninstall an app

1. On the list menu, tap **Playstore**.
2. Tap  **> My Apps**.
3. Select an app you want to uninstall.
4. Tap **Uninstall**.

Prestigio Maps & navigation



Use Google maps
Find a location
Search for a place
Get directions
Maps settings

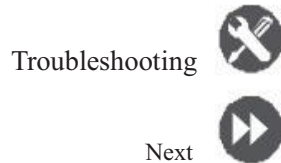

Use this application to pinpoint the location of your phone, search for places, or get directions.

Use Google maps

Google Maps lets you track your current location and receive detailed directions to your destination. It also provides a search tool where you can locate places of interest or an address on a map, or view locations at street level.

- On the home screen or list menu, tap **Maps**.



1. Find an address or place
2. Map settings
3. Get directions
4. Show your location

Find a location

Turn on or off location service

In order to find your location on your phone, you need to enable location service.

1. Go to **Settings > Location**.
2. Switch **Location** to **On**.

Find your location

- On the Maps screen, tap to find your location on the map.



If you are in an area where there are a lot of surrounding buildings, Locations may have a hard time pinpointing your location.

Prestigio



Use Google maps

Find a location

Search for a place

Get directions

Maps settings



Menu



Back

Troubleshooting



Next



Search for a place

You can search for a name of an establishment, street, or city. Suggested matches will be shown while you type.

1. On the Maps screen, tap .
2. Enter the place you want to search for.
3. Select the desired place in the result list.

Get directions

Get detailed directions to where you want to go.

1. On the Maps screen, tap  to get directions.
2. Enter your start point and endpoint.
3. Select the desired place in the result list.
4. Choose how you want to get to your destination.
5. The map opens showing the route to your destination.

Maps settings

You can set up the Google Maps, tap  > **Settings** while viewing the maps.

Prestigio Utilities



- Google search
- Alarm
- Calendar

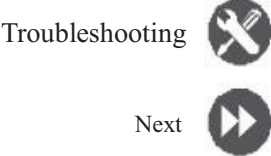

Google search

Use this application to search not only the Internet, but also apps and contents on your phone.

- On the homescreen or list menu, tap **Google**.

Search on the web or your phone

- Tap the search field, and then enter a keyword.
- Select one of the suggested keywords that appear.

Search with your voice

Use Google Voice Search to find information on the web just by speaking to your phone.

- On the homescreen or list menu, tap **Voice search**.
 - If the Google search bar is available on the Homescreen, you can also tap .
- Speak a keyword or phrase when **Speak now** appears on the screen.
- Select one of the suggested keywords that appear.
- If what you are searching for is in the list, tap the item to open it in its compatible app. Otherwise, tap **Retry** to search again.

Alarm

You can set up one or more alarms.

Set an alarm

- On the homescreen or list menu, tap **Clock**.
- On the clock screen, tap .
- Tap to add a new alarm.
- Set the alarm time, and then tap **Done**.
- If you want the alarm for multiple days, tap **Repeat**.

Turn off an alarm

- Select the alarm, and drag the check button to **Off**.

Stop an alarm

- When the alarm sounds,
- Slide to : the alarm stops.
 - Slide to : the alarm will sound again after a specific length of time.

Delete an alarm

- Tap the alarm, and then tap .

Prestigio



Google search

Alarm

Calendar



Menu



Back

Troubleshooting



Next



Calendar

You can create events and make plans on your calendar.

Create an event

1. On the home screen or list menu, tap **Calendar**.
2. Select a date, and then tap **> New event**.
3. Edit reminder settings.
4. Tap **Done** to save the event.

Manage your events

Edit an event

You can only edit events you have created.

1. While viewing your calendar, tap the event you want to edit.
2. Tap , and then make changes to the event.
3. Tap **Done**.

Delete an event

- Select the event you want to delete, and then tap .

Prestigio



Menu



Back

Troubleshooting



Next

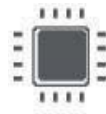

Quad core 1.2GHz



RAM 512MB+8GB eMMC



Android™6.0(Marshmallow®)



MicroSDHC/SDXC≤32GB



5.0”FWVGA
480x854 display



2MP+5MP



UMTS:900/2100MHz
GSM:850/900/1800
/1900MHz



Wi-Fi(802.11b/g/n/gps),3G,
Bluetooth2.1 A2DP



GPS,A-GPS



2000mAh



144*72*9.8(H*W*D)



115g

Prestigio Troubleshooting



Menu

Back

Troubleshooting



Next



The phone does not switch on

Remove/reinstall the battery. Then charge the phone until the battery icon stops scrolling. Unplug the charger and try to switch the phone on.

The display shows IMSI failure

This problem is related to your subscription. Contact your operator.

The network symbol is not displayed

The network connection is lost. Either you are in a radio shadow (in a tunnel or between tall buildings) or you are outside the network coverage area. Try from another place, try to reconnect to the network (especially when abroad), or contact your network operator for assistance/information.

The touchscreen responds slowly or improperly

If your device has a touchscreen and the touch screen is not responding properly, try the following:

- Remove any protective covers from the touch screen. Protective covers may prevent the device from recognizing your inputs and are not recommended for touchscreen devices.
- Ensure that your hands are clean and dry when tapping the touchscreen.
- Restart your device to clear any temporary

software bugs.

- Ensure that your device software is upgraded to the latest version.
- If the touchscreen is scratched or damaged, take it to your local dealer.

Your battery seems to over heat

You might be using a charger that was not intended for use with your phone. Make sure you always use the authentic accessory shipped with your phone.

You can not send text messages

Some networks do not allow message exchanges with other networks. First check that you have entered the number of your SMS centre, or contact your operator for detailed information on this subject.

You feel that you have missed some calls

Check your call divert options.

The display shows SIM failure

Check that the SIM card has been inserted correctly. If the problem persists, your SIM card may be damaged. Contact your operator.

Prestigio



Menu



Back

Troubleshooting



Next



Your phone is not charging

If the battery is completely flat, it might take several minutes of precharge (up to 5 minutes in some cases) before the charging icon is displayed on the screen.

The picture captured with the phone camera is not clear

Make sure that the camera lens on both sides is clean.

Your device freezes or has fatal errors

If your device freezes or hangs, you may need to close programs or reset the device to regain functionality. If your device is frozen and unresponsive, remove the battery and try to switch the phone on. The device reboots automatically.

If this does not solve the problem, perform a factory data reset. On the list menu, tap **Settings > Backup & reset > Factory data reset**.

Others cannot hear you speaking on a call

- Ensure that you are not covering the built-in microphone.
- Ensure that the microphone is close to your mouth.
- If using a headset, ensure that it is properly

connected.

Another Bluetooth device is not located

- Ensure that the Bluetooth wireless feature is activated on your device.
- Ensure that the Bluetooth wireless feature is activated on the device you wish to connect to, if necessary.
- Ensure that your device and the other Bluetooth device are within the maximum Bluetooth range (10 m).